

THE SILENTIA SCREEN SYSTEM



# The leading alternative for optimal hygiene and patient privacy

CE





We set the standard in 1990.  
 Today we have delivered 100 000  
 screens around the world.

Silentia offers a complete solution to meet privacy requirements in any health care setting. As our products are compatible with each other thanks to our EasyClick feature, a Folding Screen could easily be moved from a wall, to a trolley – or be combined with a Fixed Screen to maximize the benefits from all the system’s features.

**EasyClean™ for optimal hygiene**

The screens have smooth surfaces that withstand all disinfectants used in care situations today. The enclosed wheels can easily be removed and washed separately in a dishwasher. All products meet strict hygiene requirements and all surfaces are accessible for cleaning – that’s EasyClean.

**Folds back easily with one hand – EasyReturn™**

The patented hinges have a *built-in memory*, which enables easy handling and prevention of cross infection using only one contact point: the ergonomically designed handle.

**Fixed or mobile – the choice is yours with EasyClick™**

Movability is one click away. A wall-mounted screen can be mounted on a trolley for mobile use, or to any other of our system’s components. There are many possibilities, making this a complete system, easy to use in all departments.

**The CE mark is in accordance with the EU medical technology directive**

- Our products consist of different lengths and heights, all part of a complete system that can adapt to your specific needs.
- The lightweight construction is user-friendly and optimizes stability and safety (<5kg/m²).
- Manufactured with recyclable materials.
- Section panels are made of high-pressure laminate or polycarbonate profiles that withstand disinfectants used in any healthcare setting.

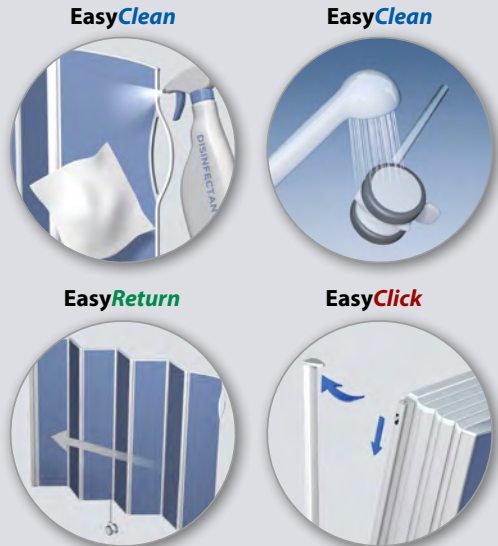





# Folding Screens

Simplicity is one of our guiding principles in product development. It has to be easy to screen off patients when they need privacy or simply want time to themselves. It also has to be easy to change things around and expand the system – so all components are designed to be compatible with each other.

**STANDARD VERSION – MOUNTED ON A WALL**  
A wall mounting permits easy fitting. EasyClick screen mounting.

The 25 cm panel width saves you valuable wall space without sacrificing patient privacy.

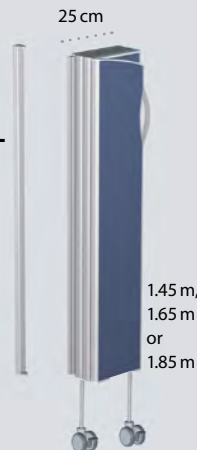

**SCREEN TROLLEY**  
Accessory for folding screens. EasyClick screen mounting.

The footprint of the wheelbase is designed to take up a minimal amount of space.



**POLE FOR FLOOR MOUNTING**

Designed to be anchored to the floor. This is applied when a free-standing screen is required. EasyClick screen mounting.



**WALL MOUNTED WITH SPACER**

Used where a screen has to be mounted a short distance from the wall, to provide clearance for a care panel for example. EasyClick screen mounting.



**MOUNTED ON WALL RAIL**

A clamp is used to mount a screen on a wall rail so that it can be moved sideways. Two wall rails should be used if the screen is longer than 2.25 m. EasyClick screen mounting.

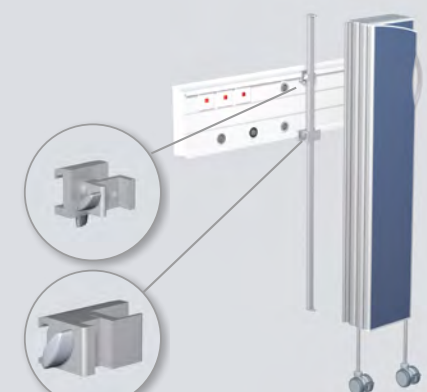



# Mobile Folding Screens

## MOUNTED ON TROLLEY

The screen can be mounted on a trolley to provide mobile privacy when necessary. This trolley is intended for Folding Screens in various lengths: from 5 to 15 sections. Height: 1.45 m, 1.65 m or 1.85 m. The patented design takes up a minimal amount of floor space, while providing maximum stability.

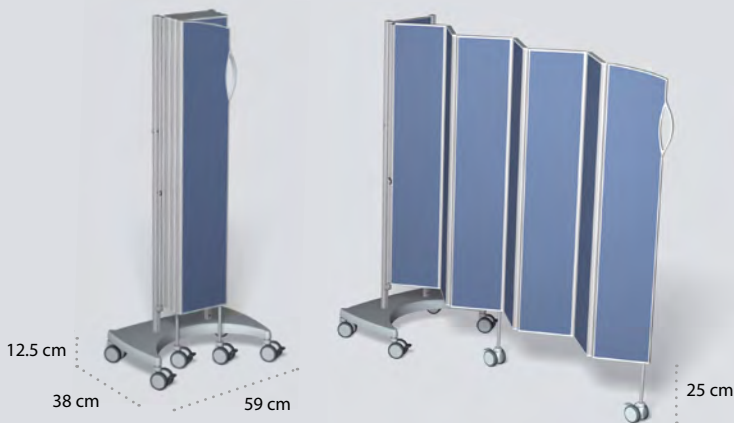





# Mobile Bed End Screens

## SILENTIA BED END SCREEN 1.5 M

Provides optimal privacy at the end of the bed – or for changing. Extended width: 1.5 m. Height: 1.55 m or 1.85 m. The patented design takes up a minimal amount of floor space, while providing maximum stability.

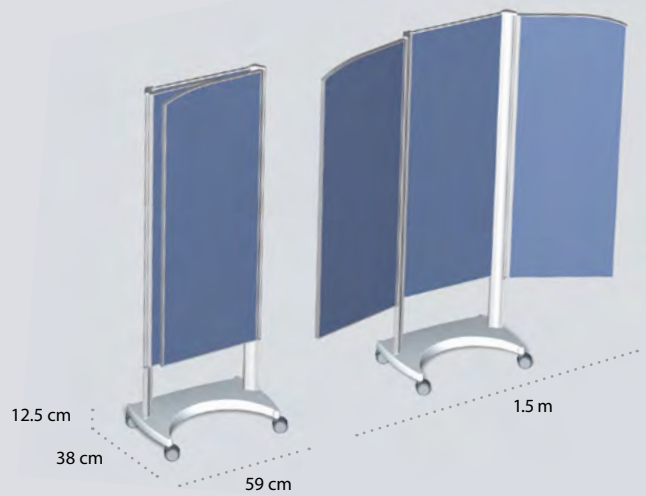
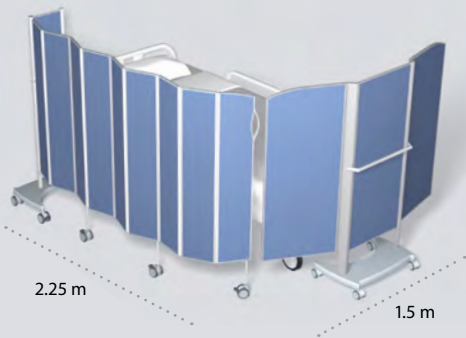

## SILENTIA BED END SCREEN 2.0 M

This new Bed End Screen is ideal when a wider solution is required. Extended width: 2.0 m. Height: 1.55 m or 1.85 m.

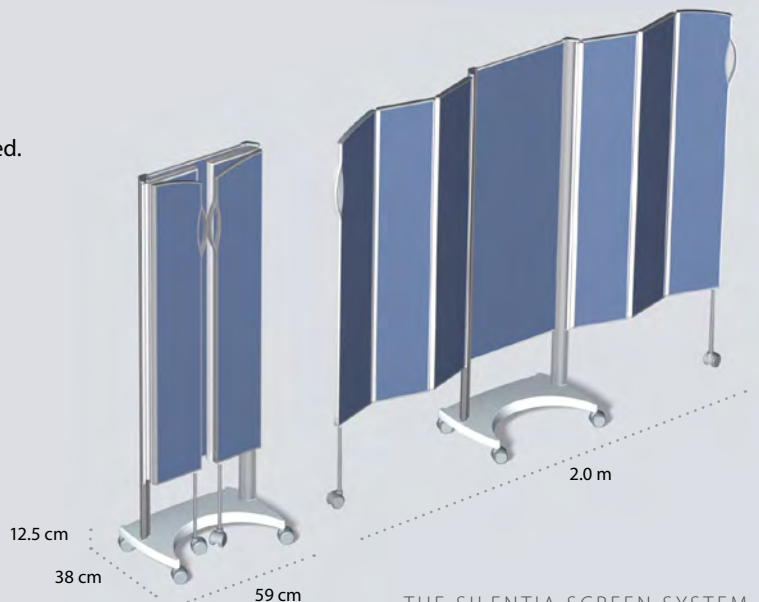
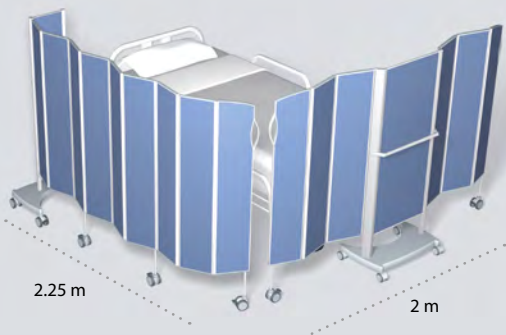



# Fixed Screens

Our Fixed Screens have been developed for applications where more permanent privacy is required. This system also permits a wider range of possibilities. A Fixed Screen between beds can for example be combined with a Folding Screen at the foot of the bed. Fixed Screens can be used to create changing cubicles and other types of rooms within a room, without making alterations to walls.

## STANDARD SIZES

LENGTH	HEIGHT	WEIGHT	ART. NO. COLOUR	ART. NO. DAYLIGHT TOP	ART. NO. DAYLIGHT TOP DUO	ART. NO. DAYLIGHT	ART. NO. DAYLIGHT DUO
1.3 m	1.45 m	6.2 kg	6150	6150-DT		6150-D	
1.3 m	1.65 m	7.2 kg	6250	6250-DT	Not available	6250-D	Not available
1.3 m	1.85 m	8.3 kg	6350	6350-DT		6350-D	
2.4 m	1.45 m	11.4 kg	6155	6155-DT	6155-DTD	6155-D	6155-DD
2.4 m	1.65 m	13.3 kg	6255	6255-DT	6255-DTD	6255-D	6255-DD
2.4 m	1.85 m	15.3 kg	6355	6355-DT	6355-DTD	6355-D	6355-DD



**DAYLIGHT, FIXED**

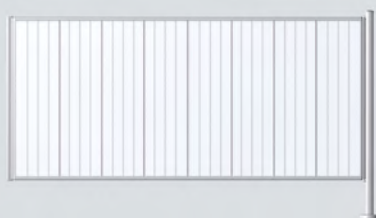

**DAYLIGHT TOP DUO, FIXED**

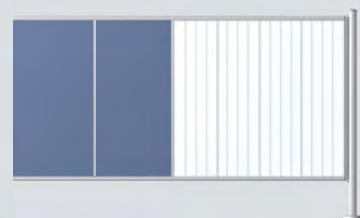

**DAYLIGHT DUO, FIXED**



**COLOUR SCREEN, FIXED**

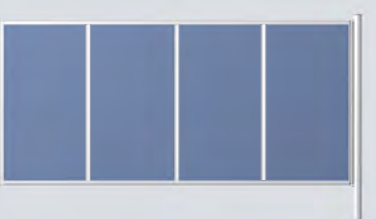

**DAYLIGHT TOP, FIXED**

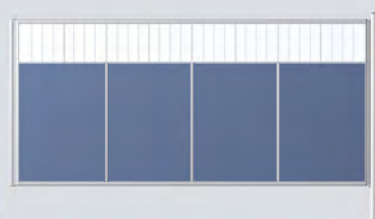





Floor Poles allow you to create a service corridor behind the head of the bed



Floor Pole attachment possibilities – seen from above.



The pole and cover of the pole at the base are attractively designed with a smooth surface that is easy to clean.

### SILENTIA FLOOR MOUNTING

A standard Floor Pole (A) is used to install a single Fixed Screen with EasyClick. If you want the pole to serve as a mounting point for additional Fixed or Folding Screens, there are special versions (B–D) with up to four mounting points.

The pole is normally secured to the floor for maximum rigidity – this is especially important if the pole supports more than one screen. If the pole is only intended to support a single wall-mounted screen, it can simply rest on the floor.

### STANDARD SIZES FLOOR POLES

HEIGHT	WEIGHT	ART. NO.	ART. NO.	ART. NO.	ART. NO.
1.45 m	3.3 kg	6561-A	6561-B	6561-C	6561-D
1.65 m	3.5 kg	6562-A	6562-B	6562-C	6562-D
1.85 m	3.8 kg	6563-A	6563-B	6563-C	6563-D



### EXTENSION SCREEN

Moves the mounting point for the Folding Screen away from the wall, either to make space for the bedside table, or to extend a Folding Screen. Available in four lengths and three heights.

HEIGHT	ART. NO. LENGTH 0.5 M	ART. NO. LENGTH 0.75 M	ART. NO. LENGTH 1.0 M	ART. NO. LENGTH 1.2 M
1.45 m	6162	6163	6164	6165
1.65 m	6262	6263	6264	6265
1.85 m	6362	6363	6364	6365

# Silentia Folding Screens

## STANDARD SIZES

NO. OF PANELS	ART. NO. COLOUR	ART. NO. DAYLIGHT TOP	ART. NO. DAYLIGHT DUO	ART. NO. DAYLIGHT	LENGTH	HEIGHT	WEIGHT	FOLDED SIZE	
								WIDTH	DEPTH
5	6105	6105-DT	6105-DD	6105-D	1.25 m	1.45 m	8.0 kg	0.25 m	0.10 m
	6205	6205-DT	6205-DD	6205-D	1.25 m	1.65 m	9.5 kg	0.25 m	0.10 m
	6305	6305-DT	6305-DD	6305-D	1.25 m	1.85 m	11.5 kg	0.25 m	0.10 m
7	6107	6107-DT	6107-DD	6107-D	1.75 m	1.45 m	12.0 kg	0.25 m	0.14 m
	6207	6207-DT	6207-DD	6207-D	1.75 m	1.65 m	14.0 kg	0.25 m	0.14 m
	6307	6307-DT	6307-DD	6307-D	1.75 m	1.85 m	16.0 kg	0.25 m	0.14 m
9	6109	6109-DT	6109-DD	6109-D	2.25 m	1.45 m	15.5 kg	0.25 m	0.18 m
	6209	6209-DT	6209-DD	6209-D	2.25 m	1.65 m	18.0 kg	0.25 m	0.18 m
	6309	6309-DT	6309-DD	6309-D	2.25 m	1.85 m	20.5 kg	0.25 m	0.18 m
11	6111	6111-DT	6111-DD	6111-D	2.75 m	1.45 m	18.5 kg	0.25 m	0.22 m
	6211	6211-DT	6211-DD	6211-D	2.75 m	1.65 m	21.5 kg	0.25 m	0.22 m
	6311	6311-DT	6311-DD	6311-D	2.75 m	1.85 m	24.5 kg	0.25 m	0.22 m
13	6113	6113-DT	6113-DD	Not available	3.25 m	1.45 m	22.0 kg	0.25 m	0.26 m
	6213	6213-DT	6213-DD		3.25 m	1.65 m	25.5 kg	0.25 m	0.26 m
	6313	6313-DT	6313-DD		3.25 m	1.85 m	29.0 kg	0.25 m	0.26 m
15	6115	6115-DT	6115-DD	Not available	3.75 m	1.45 m	25.5 kg	0.25 m	0.30 m
	6215	6215-DT	6215-DD		3.75 m	1.65 m	29.5 kg	0.25 m	0.30 m
	6315	6315-DT	6315-DD		3.75 m	1.85 m	33.5 kg	0.25 m	0.30 m

The table shows our standard sizes in 0.5 m length increments. Screens are also available in increments of 0.25 m if the total length is between 0.75 m and 3.75 m. The standard heights – 1.45 m, 1.65 m and 1.85 m – can be lowered by –0.1 m by determining the height of the legs of the wheels. The height is decided when you order your Silentia Folding Screen.

**Note:** The longest screens (12–15 sections) are intended for use in an L-shape around the bed.

### CHOOSE THE RIGHT MOUNTING TO SUIT DOOR LOCATION

**(A)** The Folding Screen mounting is normally on the left side, which means that the screen is folded to the right of the wall mounting. **(B)** To prevent the screen from taking up too much space next to a doorway for example, screens can also be ordered with the mounting on the opposite side.

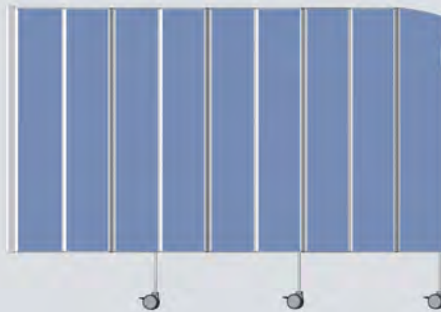

**COLOUR SCREENS**

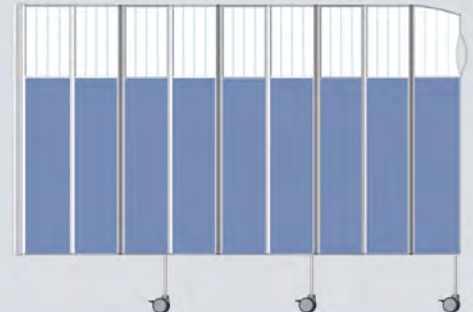

**DAYLIGHT TOP**

Daylight top section is about 0.3–0.4 m high. Depends on which panel height you choose.

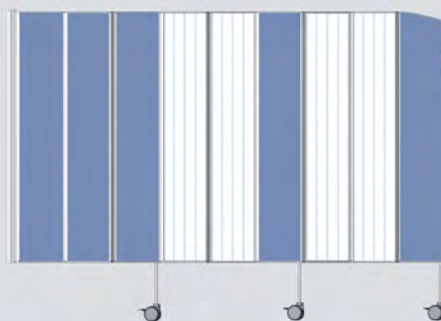

**DAYLIGHT DUO**

Frosted sections come in pairs.



**DAYLIGHT**



# Colours and patterns



## SILENTIA BED END SCREEN 1.5 M

Art. no. 6522, height 1.55 m  
Art. no. 6523, height 1.85 m

Extended width 1.5 m, folded width 0.55 m. This screen is intended for situations where a mobile screen is needed, e.g. for changing, or at the end of a bed. The small wheelbase (footprint) saves valuable floor space and its low height reduces the risk of tripping over it.



## SILENTIA BED END SCREEN 2.0 M

Art. no. 6525, height 1.55 m  
Art. no. 6526, height 1.85 m

Extended width 2.0 m, folded width 0.55 m. Provides effective privacy at end of bed, in corridors or for changing. The wheels can be locked when the screen is extended. The small wheelbase (footprint) saves valuable floor space and its low height reduces the risk of tripping over it.



## SCREEN TROLLEY

Art. no. 6514, height 1.45 m  
Art. no. 6518, height 1.65 m  
Art. no. 6520, height 1.85 m

Accessory for Folding Screens up to 15-sections long. Easy-Click screen mounting. **Note:** The longest screens (12–15 sections) are intended for use in an L-shape around the bed.

# Clamps and Spacers

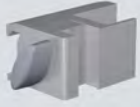

## STANDARD CLAMP FOR WALL RAIL

Art. no. 6502

For attaching to a wall rail. A flexible solution that enables the screen to be moved sideways along the wall rail. Distance between wall rail and screen: 40 mm.



## SPACER 20 MM

Art. no. 6506

Used to move a screen away from the wall, to make space for a molding for example. Supplied in pairs.



## SPACER 100 OR 200 MM

Art. no. 6507, 100 mm

Art. no. 6508, 200 mm

Used to move a screen away from the wall. Supplied in pairs.



## ADJUSTABLE SPACER

Art. no. 6509, 200–350 mm

Art. no. 6510, 300–500 mm

Used to move a screen further away from the wall. Supplied individually.



## SUPPORT CLAMP

Art. no. 6524

Used with Standard Clamp 6502 where two wall rails are mounted on the wall.



## CLAMP WITH SPACER

Art. no. 6535

A useful solution when space is required between a screen and a wall rail, such as in dialysis departments where panel access is vital. Distance between wall rail and screen: 150 mm.



## ADJUSTABLE CLAMP

Art. no. 6516

Adjusts to suit variable spacing between upper and lower wall rails. Clamps can be adjusted between 0 and 150 mm. Used together with Standard Clamp or Clamp with Spacer.

# Wall Mounting and Floor Pole



## WALL MOUNTING

Art. no. 6539, height 1.45 m  
Art. no. 6544, height 1.65 m  
Art. no. 6540, height 1.85 m

For convenient mounting directly to the wall. One Wall Mounting is normally supplied with the screen. Additional Wall Mountings can be ordered separately.



## WALL MOUNTING WITH FLOOR SUPPORT

Art. no. 6537, height 1.45 m  
Art. no. 6545, height 1.65 m  
Art. no. 6538, height 1.85 m

Wall Mounting that provides support from the floor when fitted with a clamp.



## WALL MOUNTING WITH FLOOR SUPPORT AND TOP EXTENSION

Art. no. 6541, height 1.45 m  
Art. no. 6546, height 1.65 m  
Art. no. 6542, height 1.85 m

Wall Mounting used with clamp where a wall rail crosses above the screen.



## FLOOR POLE

Art. no. 6561A, height 1.45 m  
Art. no. 6562A, height 1.65 m  
Art. no. 6563A, height 1.85 m

The Floor Pole can be used to support a wall-mounted screen or as a mounting point for Folding Screens. The pole is screwed securely to the floor. Other versions can be seen on page 7.



# Important Measurements

The Folding Screens can be mounted directly on the wall with spacers or clamps on horizontal medical rails. The different way of mounting depends on the type of room. The illustrations below show the recommended heights for medical rails, though other measurements work just as well. Contact your local distributor to get an optimal solution.

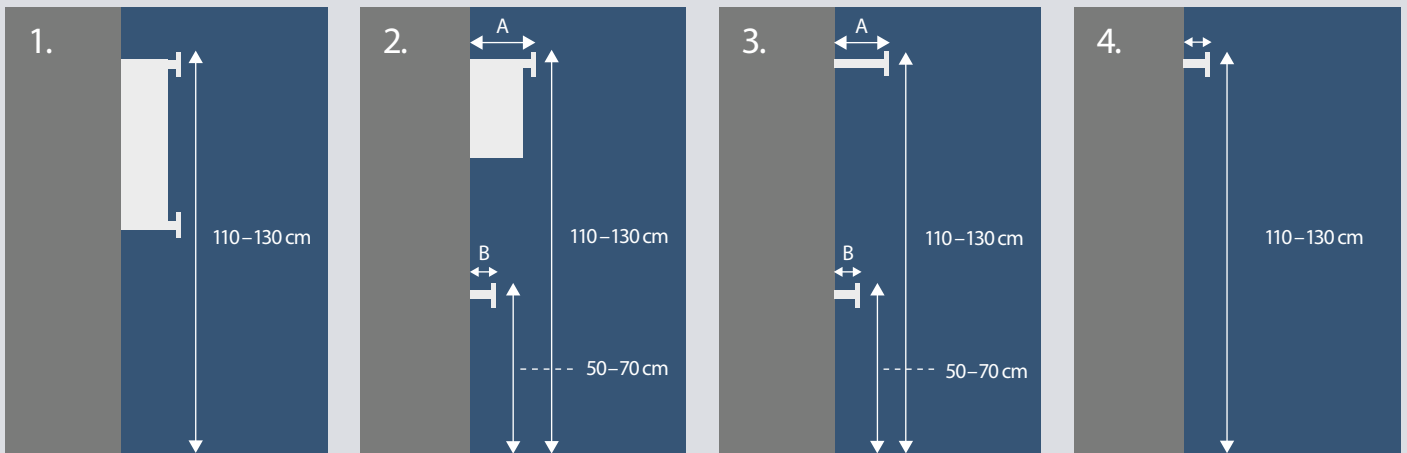

**SUPPORT CLAMP (TOP)**  
Art. no. 6524

**STANDARD CLAMP (BOTTOM)**  
Art. no. 6502

Choose this Support Clamp combination when two rails are in a vertical line. *Important measurements see no. 1.*



**CLAMP WITH SPACER (TOP AND BOTTOM)**  
Art. no. 6535

Choose this combination when you need a space between the rail and the screen for tubes and other equipment. *Important measurements see no. 1.*



**STANDARD CLAMP (TOP)**  
Art. no. 6502

**ADJUSTABLE CLAMP (BOTTOM)**  
Art. no. 6516

Choose this Support Clamp combination when one rail is closer to the wall than the other. *Important measurements see no. 2 and 3.*

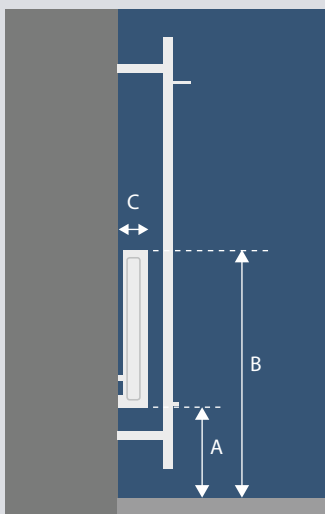

**MOUNTING IN FRONT OF RADIATOR WITH WALL MOUNT SPACER**

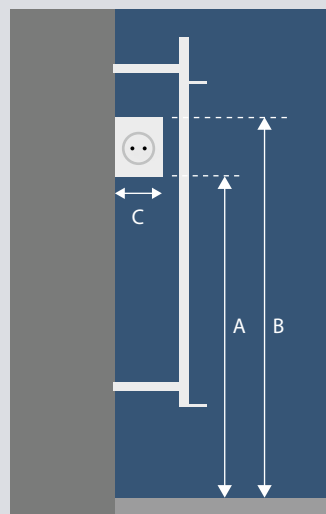

**MOUNTING IN FRONT OF A SUPPLY PANEL WITH WALL MOUNT SPACER**

When you mount a Folding Screen in front of a radiator or a supply panel, it is important to provide the following measurements when placing an order.

A. \_\_\_\_\_

B. \_\_\_\_\_

C. \_\_\_\_\_

Read more about mounting and accessories at our website.



THE FUTURE IN PRIVACY & HYGIENE SOLUTIONS

Silentia AB • Box 108, SE-311 22 Falkenberg, Sweden • Tel. +46 (0)346-485 80  
Fax +46 (0)346-485 89 • info@silentia.se • www.silentia.eu



In accordance to MDD 93/42/EEC

MADE IN SWEDEN

Our products are copyright-protected in various ways, including registered designs, patents and patents pending.  
We reserve the right to make changes without prior notice. For more information, please visit our website.